

Key in Knob & Key in Lever



We take the worry out of
protecting what's valuable to you.

Lockwood: *no worries*[®]

25YEAR MECHANICAL
WARRANTY

LOCKWOOD

ASSA ABLOY

www.lockweb.com.au

Contents



530 Series

Key in Knob & Key in Lever
Door Furniture Locksets

page 3



930/950 Series

Key in Lever
Door Furniture Locksets

page 6



Symmetry® Series

Key in Knob & Key in Lever
Door Furniture Locksets

page 10



Enable® Series

Key in Lever Locksets

page 16

530 Series Key in Knob Locksets



The 530 series is designed as a non-handed, easy-to-install lockset. This high quality range is suitable for residential and semi-commercial applications including office partitioning.

Features and Specifications

Cylinder

- 5 pin tumbler mechanism
- Brass cylinder and brass barrel

Keying

Standard Keying

- Supplied individually keyed with two keys per lock
- 78,000 key combinations
- Key blank KB2015P

Restricted Special Keying

Lockwood locks can be keyed to a number of controlled and/or specially keyed systems. These range from legally protected keys to protect against unauthorised duplication, which can also include specially designed key systems such as master key systems, which allow for different levels of mechanical access control.

Please refer to Lockwood Keying Catalogue or contact your local sales office or customer service for specific information.

Product Details

Backset	60mm standard backset. 70mm and 127mm latches available separately
Door Thickness	32 to 48mm (all functions except 534 which suits doors 32 to 45mm).
Finishes	Satin Chrome Brushed (SC)
Handing	Non-handed lockset
Latch	13mm projection brass bolt
Materials	High purity zinc alloy

Standards and Compliance



Successfully tested to 2 hours on fire door assemblies in accordance with Australian Standard AS1905.1:2005 Fire Resistant Doorsets.

530 Series Key in Knob Locksets

530

Part Number 530

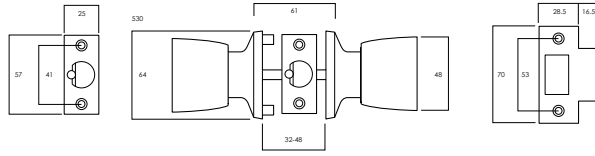

529 Exterior Escape Deadlatch

Part Number 529SC

Outside Opened by knob when unlocked. Key locks or unlocks exterior knob but does not retract bolt

Inside Opened by knob at all times. Turnbutton locks or unlocks exterior knob

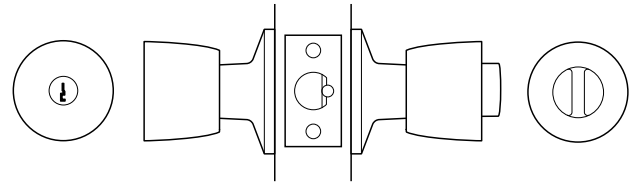

530 Entrance Set

Part Number 530SC

Outside Opened by knob when unlocked. Key locks or unlocks both knobs but does not retract bolt

Inside Opened by knob when unlocked. Turnbutton locks both knobs

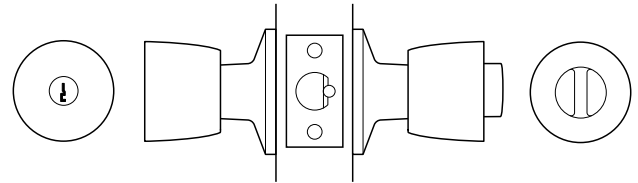

531 Passage

Part Number 531SC

Outside Opened by knob at all times

Inside Opened by knob at all times

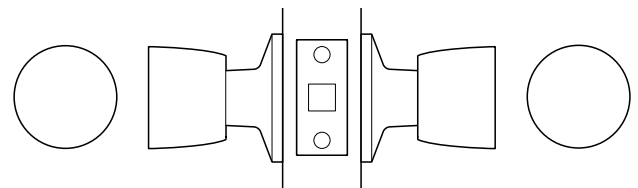

532 Privacy Set

Part Number 532SC

Outside Opened by knob when unlocked. Coin or screwdriver in emergency button unlocks both knobs but does not retract bolt

Inside Opened by knob when unlocked. Turnbutton locks both knobs

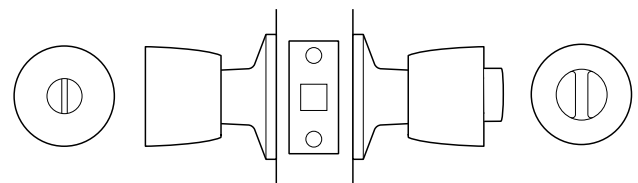

530 Series Key in Knob Locksets

534 Glass Door Set

Part Number 534SC

Outside Opened by knob when unlocked. Key locks or unlocks both knobs but does not retract bolt

Inside Opened by knob when unlocked. Key locks or unlocks both knobs but does not retract bolt

Note: For extra security against removal of the interior handle and rose, one-way mounting screws are supplied.

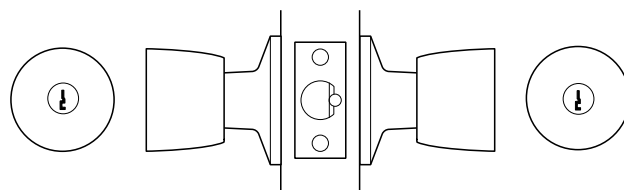

536 Escape Set

Part Number 536SC

Outside Opened by knob when unlocked. Key locks or unlocks exterior knob but does not retract bolt.

Inside Opened by knob at all times

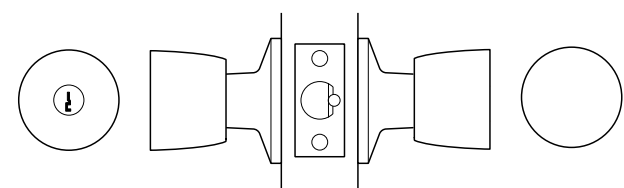

538 Storeroom Escape Set

Part Number 538SC

Outside Opened by key only. Knob is always rigid

Inside Opened by knob at all times

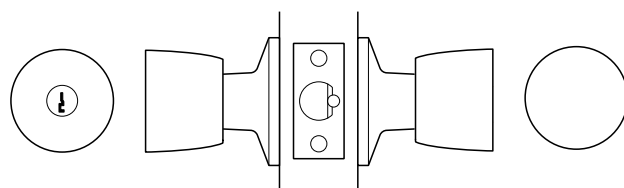

930 & 950 Series Key in Lever Locksets



The Lockwood Key in Lever Locksets feature a choice of two levers - the 930 series and the 950 series. These locksets are produced from high purity zinc alloy and are available in a comprehensive range of functions.

Features and Specifications

Cylinder

- 5 pin tumbler mechanism
- Brass cylinder and brass barrel

Keying

Standard Keying

- Supplied individually keyed with two keys per lock
- 78,000 key combinations
- Key blank KB2015P

Restricted Special Keying

Lockwood locks can be keyed to a number of controlled and/or specially keyed systems. These range from legally protected keys to protect against unauthorised duplication, which can also include specially designed key systems such as master key systems, which allow for different levels of mechanical access control.

Product Details

Backset	70mm standard backset. 60mm and 127mm latches available separately
Door Thickness	32 to 45mm (all functions except 934 and 954 which suit doors 35 to 41mm).
Finishes	Satin Chrome Brushed (SC)
Handing	Field adjustable handing
Latch	13mm projection
Materials	High purity zinc alloy. A rose cover is supplied to conceal internal fixing screws.

Standards and Compliance



Successfully tested to 2 hours on fire door assemblies in accordance with Australian Standard AS1905.1:2005 Fire Resistant Doorsets.

930 & 950 Series Key in Lever Locksets

930

Part Number 930

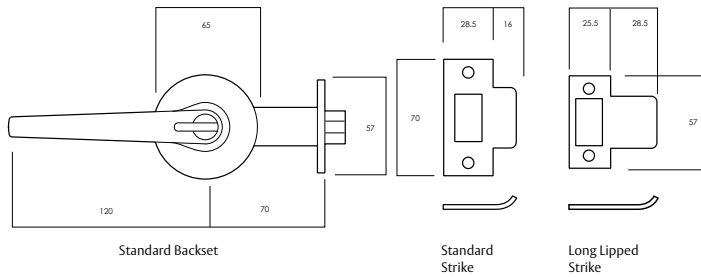
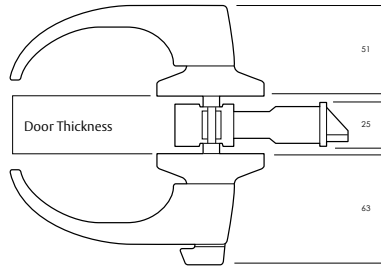

950

Part Number 950

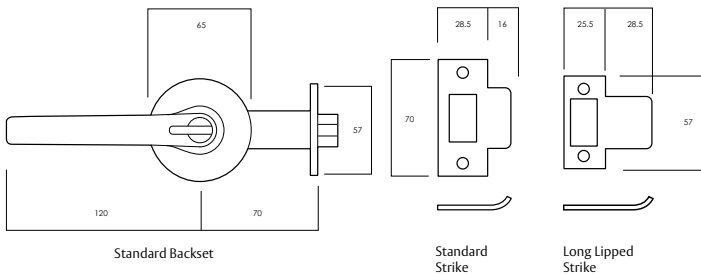
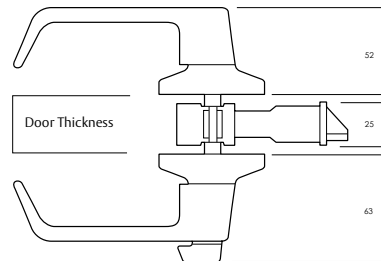

930 & 950 Series Key in Lever Locksets

929 and 949 Exterior Escape Deadlatch

Part Number 929SC, 949SC

Outside Opened by handle when unlocked. Key locks or unlocks exterior handle but does not retract the bolt

Inside Opened by handle at all times. Turnknob locks or unlocks exterior handle.

Note: 930 Series levers shown.

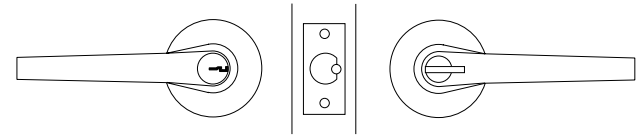

930 and 950 Exterior Deadlatch

Part Number 930SC, 950SC

Outside Opened by handle when unlocked. Key locks or unlocks exterior handle but does not retract the bolt

Inside Opened by handle when unlocked. Turnknob locks or unlocks both handles

Note: 930 Series levers shown.

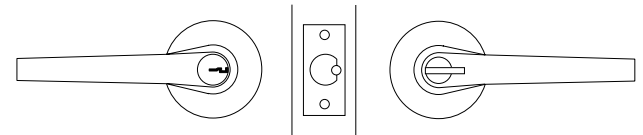

931 and 951 Passage Set

Part Number 931SC, 951SC

Outside Opened by handle at all times

Inside Opened by handle at all times

Note: 930 Series levers shown.

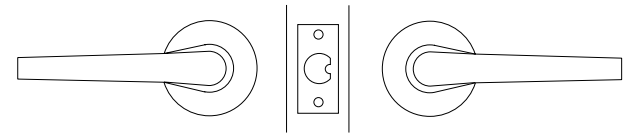

932 and 952 Privacy Set

Part Number 932SC, 952SC

Outside Opened by handle when unlocked. Coin or screwdriver in emergency button unlocks handle but does not retract bolt

Inside Opened by handle when unlocked.

Note: 930 Series levers shown.

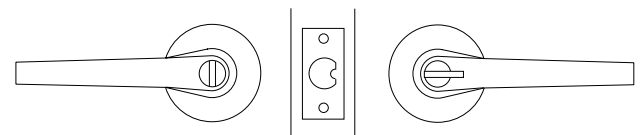

930 & 950 Series Key in Lever Locksets

934 and 954 Glass Door Deadlatch

Part Number 934SC, 954SC

Outside Opened by handle when unlocked. Key locks or unlocks both handles but does not retract the bolt.

Inside Opened by handle when unlocked. Key locks or unlocks both handles but does not retract the bolt.

Note: 930 Series levers shown. For extra security against removal of the interior handle and rose, one-way mounting screws are supplied.

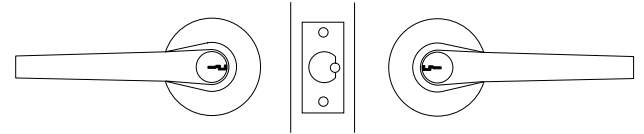

936 and 956 Exterior Escape Deadlatch

Part Number 936SC, 956SC

Outside Opened by handle when unlocked. Key locks or unlocks exterior handle but does not retract the bolt.

Inside Opened by handle at all times.

Note: 930 Series levers shown.

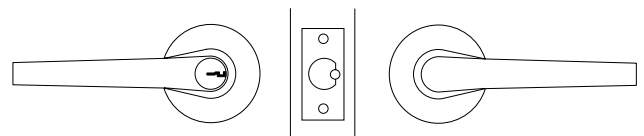

938 and 958 Storeroom Escape Deadlatch

Part Number 938SC, 958SC

Outside Opened only by key. Key retracts bolt. Outside handle is rigid at all times.

Inside Opened by handle at all times

Note: 930 Series levers shown. For extra security against removal of the interior handle and rose, one-way mounting screws are supplied.

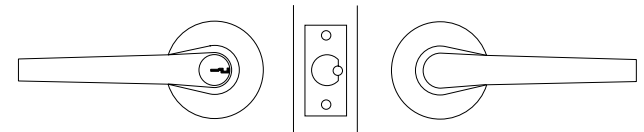

Symmetry® Key in Knob & Key in Lever



The Symmetry door handle range offers builders, developers, specifiers and interior designers a wide selection of product that can be used in any residential application

The Symmetry series is produced to meet the demanding quality and style requirements of the Australian market.

All products are tested in accordance with the security and durability requirements of the Australian Standards.

Along with the Lockwood 25 year Mechanical Warranty all Symmetry door furniture is supplied with a 5 year finish Guarantee with the exception of the Everbrass finish which has a 25 year finish Guarantee.

Keying

Standard Keying

- Supplied individually keyed with three keys per lock
- 78,000 key combinations
- Key blank KB2015P

Restricted Special Keying

Lockwood locks can be keyed to a number of controlled and/or specially keyed systems. These range from legally protected keys to protect against unauthorised duplication, which can also include specially designed key systems such as master key systems, which allow for different levels of mechanical access control. Please refer to Lockwood Keying Catalogue or contact your local sales office or customer service for specific information.

Symmetry Everbrass® Guarantee



Lockwood Everbrass® product is coated both on the exterior and interior surfaces with a lifetime anti-tarnish finish. Lockwood warrants that Everbrass® branded product will not corrode, tarnish or discolour for a lifetime when properly installed and subject to no more than fair wear and tear.

Product Details

Backset	60 to 70mm adjustable latch standard
Cylinder	5 pin Lockwood C4 brass cylinder assembly (6 pin compatible)
Functions	Entrance, privacy, passage and dummy available
Handing	Suitable for left and right handed doors
Installation	Easy to install with detailed mounting instructions
Latch	13mm throw
Strike	D-strike with anti-rattle tab as standard

Symmetry 5 Year Finish Guarantee



Lockwood guarantees to replace Symmetry product if within five years from the proven date of purchase it tarnishes, discolours or corrodes when properly installed and subject to no more than fair wear and tear.

1 ONECYL®

The exclusive one cylinder assembly solution 'OneCyl®' has been designed for the entire Lockwood Symmetry Range, which grants the convenience of cylinder interchangeability.

Symmetry® Key in Knob & Key in Lever

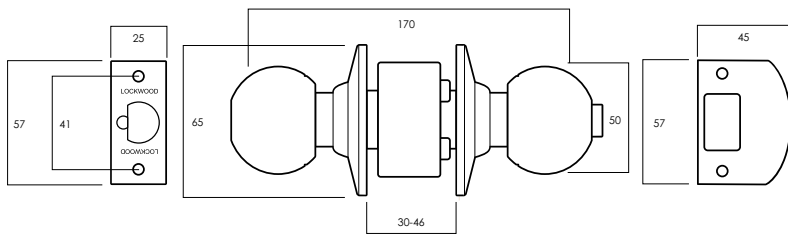

Symmetry® – Imperial Series

Part Numbers Function

7020	Entrance
7021	Passage
7022	Privacy
7025	Dummy

Standards and Compliance



Lockwood Symmetry® – Imperial Knobset has been successfully tested up to four hours (depending on type of doorset) on fire door assemblies in accordance with Australian standard As 1905.1- 2005, Part 1: Fire Resistant Doorsets.

Symmetry® – Imperial Knobset

Type Cylindrical Latch

Materials
Key in Knob: Knob–Stainless Steel and Brass
Type: Cylindrical
Chassis: Steel
Bolt Head: Stainless steel

Fixing Vertical mounting screw fixing. Fixing concealed with snap-on trim

Door Thickness 32–46mm for timber doors

Finish Polished Stainless Steel, Satin Stainless Steel

Packaging Trade Pack only

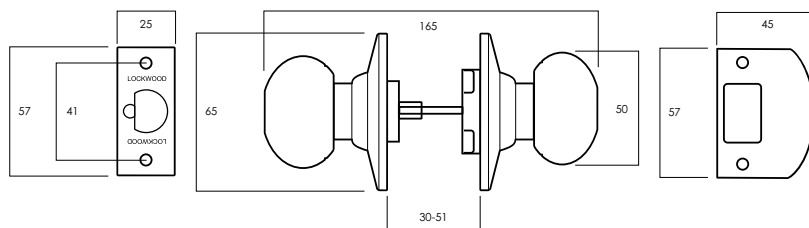

Symmetry® – Manor Series

Part Numbers Function

7010	Entrance
7011	Passage
7012	Privacy
7015	Dummy

Symmetry® – Manor Knobset

Type Tubular Latch

Materials
Key in Knob: Knob–Stainless Steel and Brass
Chassis: Steel
Bolt head: Zinc

Fixing Horizontal mounting screw fixing

Door Thickness 35–45mm for timber doors

Finish Everbrass, Polished Stainless Steel, Satin Stainless Steel, Black Chrome Plate

Packaging Trade Pack and Display Packs available

Symmetry® Key in Knob & Key in Lever

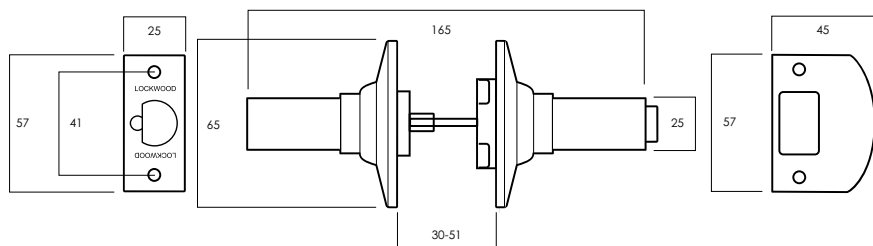

Symmetry® – Vicinity Series

Part Numbers	Function
7530	Entrance
7531	Passage
7532	Privacy
7535	Dummy

Symmetry® – Vicinity Leverset

Type Tubular Latch

Materials
Key in Lever: Zinc Alloy
Chassis: Steel
Bolt head: Zinc

Fixing Horizontal mounting screw fixing

Door Thickness 35–45mm for timber doors

Finish Everbrass, Chrome Plate, Satin Chrome Brushed

Packaging Trade Pack available. Display packs (entrance only)

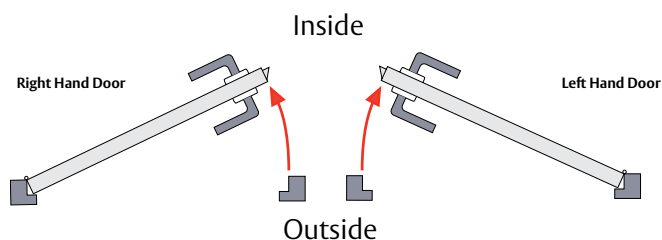

Symmetry® – District Series

Part Numbers	Function
7540	Entrance
7541	Passage
7542	Privacy
7545 or 7545L	Dummy

Symmetry® – District Leverset

Type Tubular Latch

Materials
Key in Knob: Zinc Alloy
Chassis: Steel
Bolt head: Zinc

Fixing Horizontal mounting screw fixing

Door Thickness 35–45mm for timber doors

Finish Everbrass, Chrome Plate, Satin Chrome Brushed

Packaging Trade Pack only available

Symmetry® Key in Knob & Key in Lever

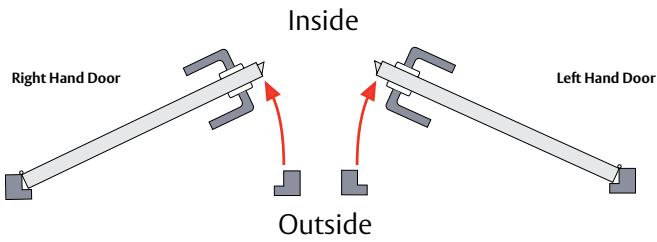

Symmetry® – Element™ Series

Part Numbers	Function
7550	Entrance
7551	Passage
7552	Privacy
7555	Dummy

Symmetry® – Element™ Leverset

Type	Tubular Latch
Materials	Key in Lever: Zinc Alloy
	Chassis: Steel
	Bolt head: Zinc
Fixing	Horizontal mounting screw fixing
Door Thickness	35–45mm for timber doors
Finish	Chrome Plate, Satin Chrome Brushed
Packaging	Trade Pack and Display Pack available

Symmetry® Series - Accessories

Single and Double Cylinder Deadbolt

Part Numbers	Function
7106	Single Cylinder
7107	Double Cylinder

Recommended to be used in conjunction with all Symmetry knob and lever styles. Single Cylinder – key operation from outside and a turn knob from the inside. Double Cylinder – key operation from outside and inside.

Note: For added security a deadbolt should be fitted in addition to the handle set. Refer to Lockwood Deadbolts Catalogue for range and part number information.



Single Cylinder Deadbolt



Double Cylinder Deadbolt

Universal Rebate Kit

Part Number	Description
7579	Universal Rebate Kit

The Symmetry series of Key in Knob, Key in Lever and Deadbolt products can be converted for use on rebated double doors with a standard 12 to 13mm rebate by installation with this Universal Rebate Kit.

Note: Surface mounted strike box available. A wide selection of Flush Pulls, Latches and Strikes are available in trade pack to complement the Symmetry Door Furniture Collection.

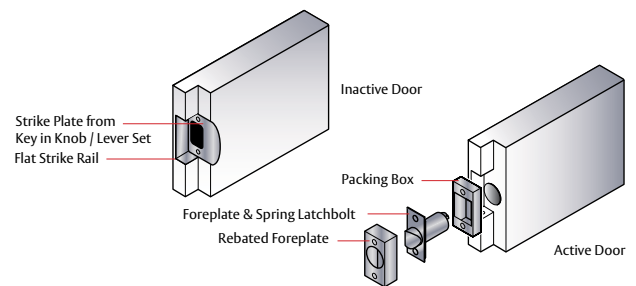

Sliding Door Sets

Part Numbers	Description	Function
7300	Square Sliding Doorset	Privacy
7350	Square Sliding Doorset	Passage
7506	Square Sliding Doorset	Flush Pull
7400	Round Sliding Doorset	Privacy
7410	Round Sliding Doorset	Passage & Latchset
7444	Round Sliding Doorset	Entrance
7450	Round Sliding Doorset	Flush Pull

Symmetry Sliding Doorsets suit most sliding cavity doors. Available in entrance (round), passage and privacy functions in display pack only.

Note: A wide selection of Flush Pulls, Latches and Strikes are available in trade pack to complement the Symmetry Door Furniture Collection.



Sliding Doorsets

Flush Pull

Flush Pulls



7444 Entrance Set



7450 Passage Set



7400 Privacy Set
7410 Latch Set

Symmetry® Key in Knob & Key in Lever

Ordering Procedure

Sample part number 7010SSKA is made up of several sections. Choose your product by selecting an option from each section.

Symmetry® Series



Locksets Series	Function	Finish	Packaging	Keying
701	0	SSS		KA

Lockset Series	Function	Finish	Packaging	Keying
Imperial 702	Entrance 0	Everbrass EVB*	Display Pack DP	Special Keying-Residential Keyed Alike 5P 5KA
Manor 701	Passage 1	Chrome Plate CP	Trade Pack TP	Keyed Alike 6P 6KA
Vicinity 753	Privacy 2	Polished Brass PB		Project Keyed 5P 5PK
District 754	Dummy 5	Polished Stainless Steel PSS		Projected Keyed 6P 6PK
Element™ 755		Satin Chrome Brushed SC		Restricted Profile 5P 5RP
		Satin Stainless Steel SSS		

*EVB finish is only available in Manor & District Lockset Series

Note: Ordering 7010SSS without specifying keying requirements will be considered as a key to differ (KD)

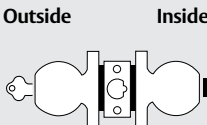
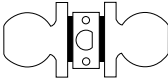
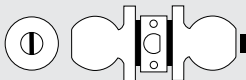
Function Table

Function	Function #	Key in Knob or Key in Lever	Operation
Entrance	0		<p>For front doors, back doors and garages, when security is required.</p> <p>Outside: Opened by knob when free. Key locks/unlocks both knobs.</p> <p>Inside: Opened by knob when free. Tubular – Turn snib locks/unlocks both knobs. Cylindrical – Pushbutton will lock outside knob. Turning inside knob or outside key releases pushbutton automatically.</p> <p>Latch: Deadlatch.</p>
Passage	1		<p>For passage, hall and closet doors, when no locking is required.</p> <p>Outside/Inside: Opened by knob at all times.</p> <p>Latch: Plainlatch.</p>
Privacy	2		<p>For use in bedrooms, bathrooms and toilets, where privacy is required. Includes kick off feature.</p> <p>Outside: Opened by knob when free. Includes emergency release – locked door can be opened by coin or screwdriver.</p> <p>Inside: Opened by knob when free. Tubular – Turn snib locks/unlocks both knobs. Cylindrical – Pushbutton will lock outside knob. Turning inside knob releases pushbutton automatically and will unlock outside knob.</p> <p>Latch: Plain latch.</p>
Dummy Knob	5		<p>For use when only a door pull is required. Fixed knob without latch or lock. Decorative door pull. Knob will not turn.</p>

Enable® Series Key in Lever Locksets



The new AS1428.1 Lockwood compliant leverset features a right angle return of 20mm length and good clearance from the door to prevent fingers slipping off during use. A push button on the interior side lever of the Exterior and Privacy Sets allows a single action egress function. This leverset is designed to enable positive grip and is suitable for door thickness of 35mm to 45mm.

Door Clearance

To ensure correct functioning of the lockset, the clearance between the door and frame should be at least 3mm.

Features and Specifications

Cylinder

- Available in Exterior, Privacy, Passage, Single Dummy, Storeroom, Classroom, Glass Door and Lever/ Knob Combination sets
- Supplied with a standard "PD" type cylinder keyed to C4 profile with two keys
- Suitable for residential and commercial applications

Restricted Special Keying

Lockwood locks can be keyed to a number of controlled and/or specially keyed systems. These range from legally protected keys to protect against unauthorised duplication, which can also include specially designed key systems such as master key systems, which allow for different levels of mechanical access control.

Product Details

Backset	60 to 70mm adjustable backset latch
Door Thickness	35 to 45mm
Finishes	Satin Chrome Brushed (SC)
Handing	Non handed
Latch	13mm projection
Materials	High purity zinc alloy. Concealed fixing screws

Standards and Compliance



Lockwood Enable® Range Locksets have been successfully tested up to 2 hours (depending on type of doorsets) on fire door assemblies in accordance with Australian Standard AS1905.1-2015, Part 1: Fire Resistant Doorsets.

Enable® Series Key in Lever Locksets

Enable® Series KNL

Part Number KL2D005C

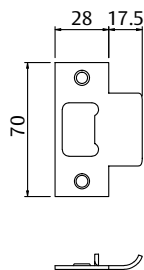
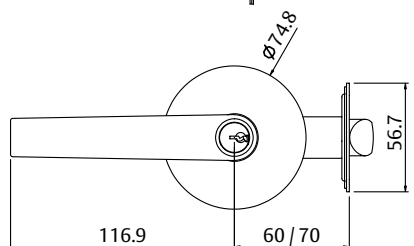
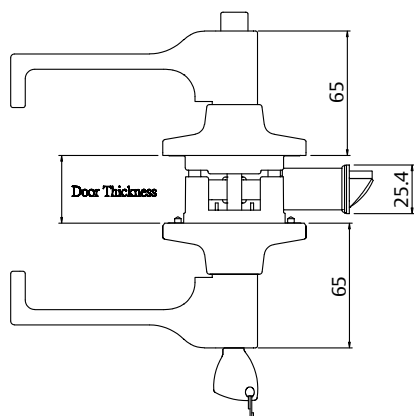

Enable® Series Key in Lever Locksets

Exterior Deadlatch

Part Number	KL2D005C
Outside	Unlocked by key or when push button inside is released
Inside	Operating lever unlocks push button. Closing door does not release push button

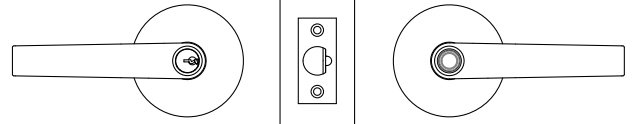

Passage Set

Part Number	KL2D105C
Outside	Opened by lever at all times
Inside	Opened by lever at all times

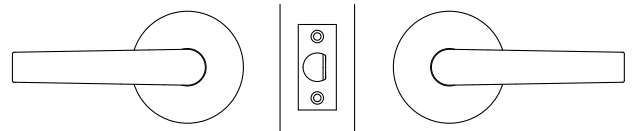

Privacy Set

Part Number	KL2D205C
Outside	Locked by push button inside Unlocked by emergency release outside
Inside	Operating lever unlocks push button

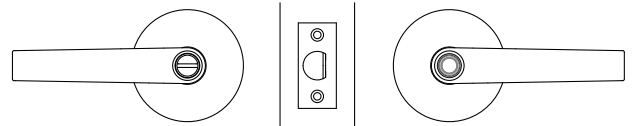

Double Cylinder Glassdoor Set

Part Number	KL2D405C
Outside	Opened by lever from either side except when both levers are locked by key from either side
Inside	Opened by lever from either side except when both levers are locked by key from either side

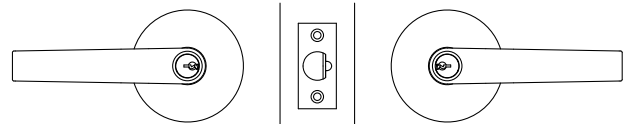

Enable® Series Key in Lever Locksets

Single Dummy

Part Number	KL2D50SC
Outside	Single dummy on one side of door
Inside	Single dummy on one side of door

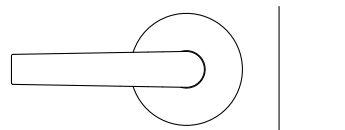

Classroom Set

Part Number	KL2D60SC
Outside	Locked by key
Inside	Opened by lever at all times

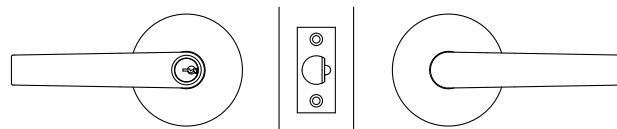

Storeroom Set

Part Number	KL2D80SC
Outside	Always locked unless key is in lever permitting the lever to retract the latch
Inside	Opened by lever at all times

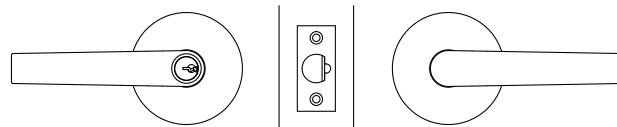

Lever/Knob Combination Set

Part Number	KLK2D00SC
Outside	Knob unlocked by key or when push button is released
Inside	Operating lever unlocks push button. Closing door does not release push button

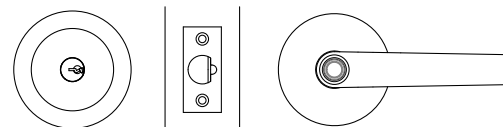

Enable® Cylindrical Series Key in Lever Locksets



The new Lockwood Enable® Cylindrical Locksets are AS1428.1 compliant and incorporate a cylindrical chassis design housing a PD cylinder. This Lockwood Commercial Series offers a wide range of functions and is available in both 60mm and 70mm backsets. The lever is designed to enable positive grip to prevent fingers slipping off during use. A push button on the interior lever of the Exterior and Privacy Sets allows a single action egress function.

The new Lockwood Enable® Cylindrical Lockset range is available in Trade Pack and is suitable for a broad range of applications.

Door Clearance

To ensure correct functioning of the lockset, the clearance between the door and frame should be at least 3mm.

Features and Specifications

Cylinder

- Standard “PD” type cylinder keyed to C4 profile with two keys
- Available in Exterior, Privacy, Passage, Dummy, Storeroom, Classroom Glass Door sets, Latching Halfset and Double Cylinder Storeroom

Restricted Special Keying

Lockwood locks can be keyed to a number of controlled and/or specially keyed systems. These range from legally protected keys to protect against unauthorized duplication, which can also include specially designed key systems such as master key systems, which allow for different levels of mechanical access control.

Product Details

Backset	Standard 70mm backset but 60mm also available
Door Thickness	35 – 46mm
Finishes	Satin Chrome Brushed (SC)
Handing	Handing is field changeable
Latch	Stainless Steel latch bolt

Standards and Compliance



Lockwood Enable® Cylindrical Range Locksets have been successfully tested up to 2 hours (depending on type of doorsets) on fire door assemblies in accordance with Australian Standard AS1905.1-2015, Part 1: Fire Resistant Doorsets.

Enable® Cylindrical Series Key in Lever Locksets

Enable® Cylindrical Series

Part Number KL17D00SC

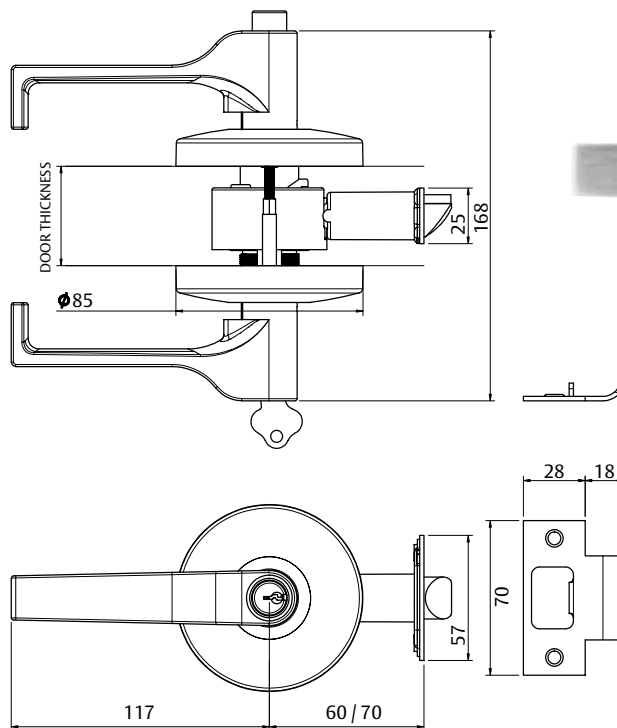

Enable® Cylindrical Series Key in Lever Locksets

Exterior Deadlatch

Part Number	KL17D00SC (70mm backset) KL16D00SC (60mm backset)
Outside	Opened by handle when unlocked. Key unlocks exterior handle.
Inside	Opened by handle at all times. Push button locks exterior handle.

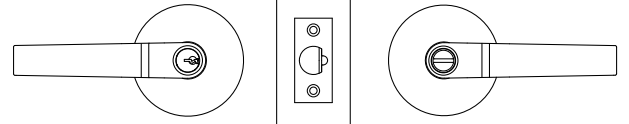

Passage Set

Part Number	KL17D10SC (70mm backset) KL16D10SC (60mm backset)
Outside	Opened by handle at all times.
Inside	Opened by handle at all times.

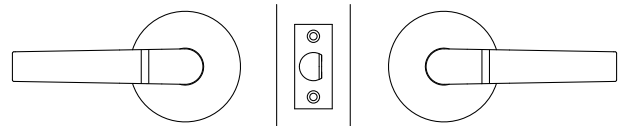

Privacy Set

Part Number	KL17D20SC (70mm backset) KL16D20SC (60mm backset)
Outside	Opened by handle when unlocked. Coin or screwdriver in emergency button unlocks handle.
Inside	Opened by handle at all times. Push button locks exterior handle.

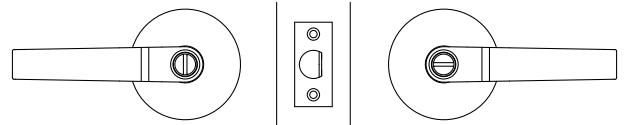

Latching Halfset

Part Number	KL17D30SC
Outside	Blank Plate
Inside	Opened by handle at all times.

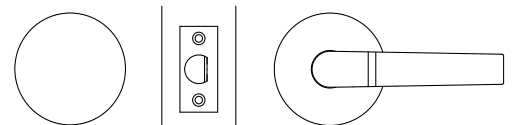

Glass Door Set

Part Number	KL17D40SC (70mm backset) KL16D40SC (60mm backset)
Outside	Opened by handle when unlocked. Key locks or unlocks both handles.
Inside	Opened by handle when unlocked. Key locks or unlocks both handles.

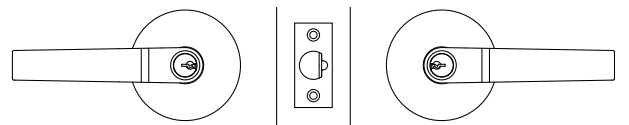

Enable® Cylindrical Series Key in Lever Locksets

Dummy Set

Part Number	KL17D50SC
Outside	For use where only a door pull is required.
Inside	For use where only a door pull is required.

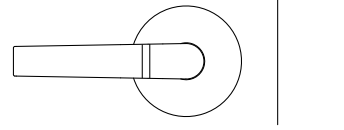

Classroom Set

Part Number	KL17D60SC (70mm backset) KL16D60SC (60mm backset)
Outside	Opened by handle when unlocked. Key locks or unlocks exterior handle.
Inside	Opened by handle at all times.

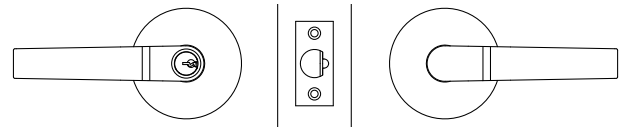

Storeroom Set

Part Number	KL17D80SC (70mm backset) KL16D80SC (60mm backset)
Outside	Opened by key only. Outside handle is rigid at all times.
Inside	Opened by handle at all times.

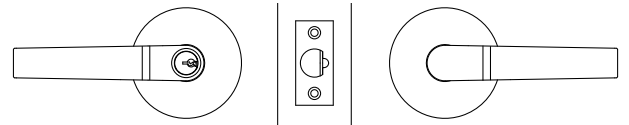

Double Cylinder Storeroom

Part Number	KL17D90SC
Outside	Opened by key only. Outside handle is rigid at all times.
Inside	Opened by key only. Inside handle is rigid at all times.

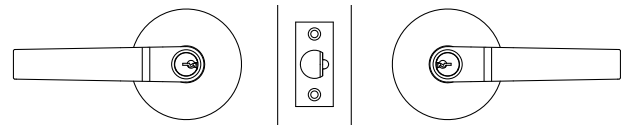

Latches

Part Numbers	Function
SPL/DL60/SC	Lockwood Enable® Cylindrical Deadlatch 60mm
SPL/DL70/SC	Lockwood Enable® Cylindrical Deadlatch 70mm
SPL/PL60/SC	Lockwood Enable® Cylindrical Plain Latch 60mm
SPL/PLP60/SC	Lockwood Enable® Cylindrical Privacy Latch 60mm



Lockwood is the leading brand in the Australian locking industry. With an established reputation for high quality products, this iconic brand provides a wide range of locking solutions to residential housing, commercial, semi-commercial, building and industrial application markets. Lockwood is supported by an extensive distribution and after-sales support network. Our customers include retailers, architects, trade and industrial personnel, locksmiths and security dealers.

ASSA ABLOY is the global leader in door opening solutions, dedicated to satisfying end-user needs for security, safety and convenience.

ASSA ABLOY is represented in all major regions, in both mature and emerging markets, with leading positions in Australia, Europe and North America.



The Lockwood 25 Year Mechanical Warranty

Our belief that we manufacture the finest premium products available in today's market place is backed by the Lockwood 25 Year Mechanical Warranty, ensuring that Lockwood continues to keep Australians safe by delivering security and peace of mind.

For warranty terms and conditions, please visit www.lockweb.com.au or call **1300WARRANTY**

ASSA ABLOY Opening Solutions Australia
235 Huntingdale Road
Oakleigh, Victoria, 3166
Australia

1300 LOCK UP (1300 562 587)
lockweb.com.au

ASSA ABLOY New Zealand Ltd
6 Armstrong Road
Albany, Auckland, 0632
New Zealand

nzsales@assaabloy.com
Telephone +64 9415 7111
assaabloyopeningsolutions.nz

Disclaimer

Whilst every effort has been made to ensure that the information (including product images and drawings) contained in this brochure is accurate at the time of publication, ASSA ABLOY Australia Pty Limited ("ASSA ABLOY") recommends that you consult ASSA ABLOY or its agents prior to placing an order to ascertain current information on specific products, as ASSA ABLOY reserves the right to make changes without notice. ASSA ABLOY will not be liable for any injury, loss or damage whatsoever, arising from any errors or omissions in the information contained in the brochure or arising from the use or application of the information contained herein. © 2023 copyright by ASSA ABLOY All rights reserved